

Concept Pro



2MP

ENHANCED
LOW
LIGHT

10X
ZOOM

4 in1

CP-HSD210A-AHD2M

Concept Pro 2MP AHD 10x Zoom High Speed Dome

The Concept Pro 2MP AHD 10x PTZ Camera (CP-HSD210A-AHD2M) is a 1080P AHD high-speed dome with 10x optical zoom. The camera can be programmed with 128 preset positions and up to 4 preset tours, scans and patterns allowing for virtually hands-free operation. The PTZ features 4 alarm inputs and 1 output for peripherals such as PIR sensors and integrating with devices such as intruder alarms. Additionally, the camera offers 300 degrees/s rotation speed ensuring movement of the camera remains responsive even when operated remotely from other locations.



Parking Action

The Concept Pro 2MP AHD 10x PTZ Camera (CP-HSD210A-AHD2M) can be configured to run a specified preset, scan, pattern or group after a defined period of inactivity.

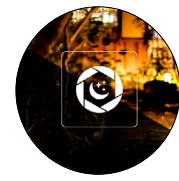

Enhanced Low Light

Enhanced Low-Light harnesses Sony's Starvis technology to produce clear and crisp colour images where light is at a premium, this ensures our products with Enhanced Low-Light stay in colour for longer.

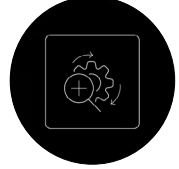

Superior Image Quality Through The Zoom

Each camera will retain image focus when they zoom and micro-stepping technology makes the Pan and Tilt motion smooth, even at maximum optical zoom.

KEY FEATURES

- ◆ 2MP Analogue High Definition
- ◆ Lens Size 5.1-51mm
- ◆ AHD/TVI/CVI/CVBS
- ◆ Enhanced Low light performance
Colour @ 0.01 Lux
- ◆ IP66
- ◆ 4 Alarm inputs and 1 Alarm outputs

OTHER FEATURES

- ◆ 128 Presets
- ◆ 4 Preset group tours
- ◆ 10x Optical Zoom
- ◆ Home Position (Idle/Parking Action)
- ◆ Lightning and Power Surge Protection

ANALOGUE HD TYPICAL CABLE DISTANCE



	2MP	720P
COAX (RG59)	UP TO 500M	UP TO 500M
CAT5e	UP TO 305M	UP TO 350M
CAT6	UP TO 305M	UP TO 350M

*Approximate distances calculated using HD MasterBaluns. Actual transmission range will vary depending on type and quality of cable and baluns.

CP-HSD210A-AHD2M

Concept Pro 2MP AHD 10x Zoom
High Speed Dome

Concept Pro

SPECIFICATION

Model/Feature	CP-HSD210A-AHD2M
Image Sensor	1/2.9" Progressive Scan
Video Output	AHD/TVI/CVI/CVBS
Max. Resolution	1920 x 1080 (2MP)
Frame Rate	25/30FPS @ 1920 x 1080
Min. Illumination	Color:0.01Lux@(F1.2,AGC ON); B/W:0.01lux
White Balance	Auto
Gain Control	Auto
S/N Ratio	≥52dB
Noise Reduction	Auto / Off / Low / Middle / High
Backlight compensation	On/Off
Highlight compensation	On/Off
Wide Dynamic Range	DWDR, OFF/ON
Defog	/
Shutter Speed	PAL:1/50-1/50000s, NTSC:1/60-1/60000s
Day/Night	Ext / AUTO / Color / MONO
Digital Zoom	/
Focal Length	5.1~51mm
Optical Zoom	10x
Zoom Speed	Approx.4.2s(Optical Wide-Tele)
Aperture	F1.6(Wide)~F2.5(Tele)
Angle of View	Appr. 68°(Wide) to 6.7°(Tele)
Focus	Auto/Semi-automatic/Manual
Iris	Fixed
Pan/Tilt Range	Pan: 360° Endless, Tilt: 90°
Speed	Pan: 0.1°/s ~300°/s ,Tilt: 0.1°/s ~180°/s,
Proportional Speed	As the length of focus, to auto-adjust the speed
Preset	128
Auto Scan	4
Pattern	4
Group (Tour)	4
Schedule	16
Auto Flip	Yes
Power Off Memory	N/A
Park Action	Yes
Power Up Action	Yes
Auto Protocol ID	Yes
Illumination Range	N/A
IR Mode	Auto/Manual
IR LED Power Consumption	N/A
IR LED Current	N/A
Video Output Connector	1 BNC
RS485	Yes
Protocol	Pelco-D/Pelco-P
Baud Rate	2400/4800/9600
Up the Coax	Yes
Alarm Inputs	4
Alarm Outputs	1
Alarm Trigger Event	Alarm I/O, Schedule
Audio Inputs	N/A
Dimensions	144x144x130mm
Gross Weight	1.3kg
Operating Temperature	-40 °C ~ 60 °C (-40°F ~ 140 °F)
Operating Humidity	≤90% (Non-condensing)
Power Supply	DC24V 1A / AC24V 2A
Power Consumption	5W
Ingress Protection	IP66
Impact Protection	N/A
Surge Protection	TVS4000V
Certification	CE/FCC

DIMENSIONS

All measurements are in mm.

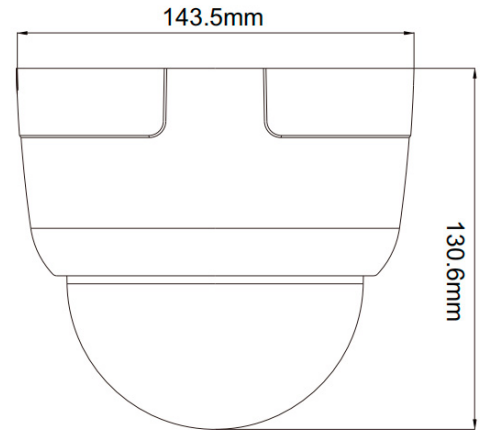

ORDER CODE

- **CP-HSD210A-AHD2M** Concept Pro 2MP Small AHD 10x Zoom High Speed Dome

OTHER PRODUCTS IN THE RANGE

- **CP-HSD230-IP2M** Concept Pro 2MP IP 30x Zoom High Speed Dome
- **CP-HSD230-IP3M** Concept Pro 3MP IP 30x Zoom High Speed Dome
- **CP-HSD220D-AHD2M** Concept Pro 2MP 6 Inch AHD 20x Zoom High Speed Dome
- **CP-HSD233E-AHD2M** Concept Pro 2MP 8 Inch AHD 33x Zoom High Speed Dome
- **CP-HSD212A-IP4M** Concept Pro Small 4MP IP 12x Zoom High Speed Dome

RECOMMENDED ACCESSORIES

- **CP-HSDB2-PMA** Concept Pro Small PTZ Pendant Mount
- **CP-HSDB2-PA** Concept Pro Small PTZ Pole Mount
- **CP-HSDB2-WMA** Concept Pro Small PTZ Wall Mount
- **CP-HSDB2-CMA** Concept Pro Small PTZ Corner Mount

CP-HSD210A-AHD2M

Concept Pro 2MP AHD 10x Zoom
High Speed Dome

Concept Pro

ACCESSORIES

DIMENSIONS

CP-HSDB2-PMA

Concept Pro Small PTZ Pendant Mount

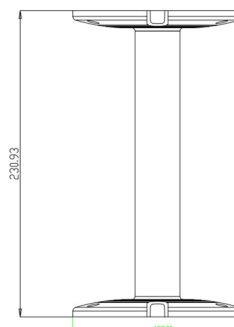

CP-HSDB2-PA

Concept Pro Small PTZ Pole Mount

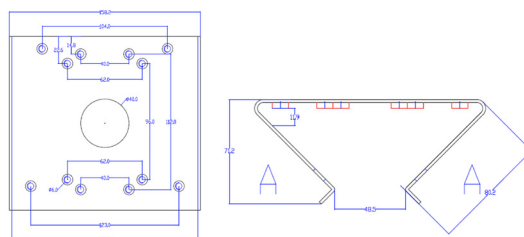
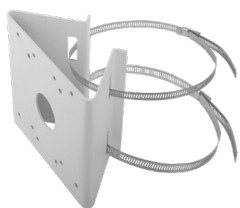

CP-HSDB2-WMA

Concept Pro Small PTZ Wall Mount

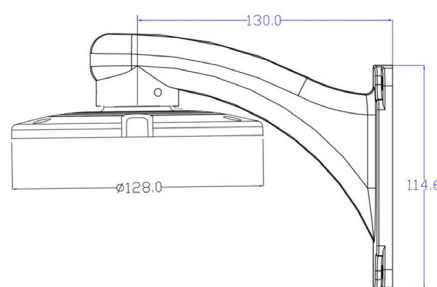

CP-HSDB2-CMA

Concept Pro Small PTZ Corner Mount

