



Concept Pro

5MP
**2.8-12mm
Motorised
Lens**
**30M
IR**
IP

CVP9329DEIREL-IP5M-Z CVP9329DEIREL-IP5M-Z-G

Concept Pro 5MP IP Enhanced Low Light Motorised External Eyeball Camera

The CVP9329DEIREL-IP5M-Z model is an IP camera that has been designed to deliver the highest image quality for external environments. This external eyeball features a motorised lens, smart infrared LEDs with 30m illumination range, and provides crisp 5-megapixel video. It comes equipped with alarm and audio functionality as well as a power output for the most advanced installation needs. This camera is also designed for excellent compatibility with the Concept Pro range of network video recorders.



Deep Learning Motion Detection

Reduce false motion detection alarms by up to 95% using new Deep Learning Motion Detection technology. Trained with deep learning algorithms, the camera can recognise and trigger motion detection events only if a person is detected in the specified area. As a result, false alarms from sources such as lights, animals, foliage, weather, and other objects are effectively filtered and reduced.



Intelligent, Efficient Bit Rate Control

Reduce camera streaming bit rates by up to 90% by using Variable Bit Rate (VBR) or VBR+ smart bit rate control settings. These dynamic features maximise overall image quality while minimising camera stream bit rates. This results in lower network bandwidth usage and extended recording storage retention time.

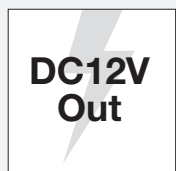

DC12V Power Output

This CCTV camera also provides a DC12V 100mA power output that can be conveniently used to power some auxiliary equipment rather than using a separate power supply adapter.

KEY FEATURES

- ◆ Max. 25FPS @ 5MP
- ◆ 2.8-12mm Motorised Lens
- ◆ Up to 30m Smart IR Illumination
- ◆ Deep Learning Motion Detection
- ◆ H.265 Video Codec & VBR+ Smart Bit Rate Control
- ◆ Alarm & Audio I/O

OTHER FEATURES

- ◆ PoE/DC12V/AC24V Power Input & DC12V Power Output
- ◆ True WDR, ATW, BLC, Defog, 3D-DNR
- ◆ Manual Regions of Interest
- ◆ ONVIF Profile S Compliant

**COMPATIBLE
WITH**

**CONCEPT PRO
IP RECORDING
RANGE**

CVP9329DEIREL-IP5M-Z CVP9329DEIREL-IP5M-Z-G

Concept Pro 5MP IP Enhanced Low Light
Motorised External Eyeball Camera

Concept Pro

SPECIFICATION

Model/Feature	CVP9329DEIREL-IP5M-Z CVP9329DEIREL-IP5M-Z-G	
Video Output Type	IP	
Image Sensor	1/2.8" Progressive Scan CMOS	
Signal System	PAL/NTSC	
Min. Illumination	Enhanced Low Light Performance Colour: 0.003 Lux @ (F1.4, AGC ON) B&W: 0 lux with IR LEDs on	
Camera	Electronic Shutter	Auto/Manual, 1/25 to 1/5,000s
	S/N Ratio	≥48.8dB
	IR LEDs	x4
	IR Illumination Range	Max. 30m
	IR Control	Auto/Off
	Adaptable IR	Auto
	Pan/Tilt/Rotation Range	Pan: 0°-360°, Tilt: 0°-90°, Rotation: 0°-360°
	Lens Type	Motorised
	Mount Type	Built-in
	Focal Length	f=2.8-12mm
Lens	Aperture	F1.4
	Angle of View	H: 95.9-29.8°, V: 67.3-22.3°, D: 123.7-36.51°
Video	Focus	Auto/Manual
	Iris	DC Auto Iris
	Compression	H.265/H.264 with VBR+ Smart Codec Option
	Streaming Capability	Triple Streaming + SVC Stream
	Resolution	2592x1944, 2592x1520, 2304x1296, 2048x1536, 1920x1080, 1280x1024, 1024x768, 1280x720, 704x576, 704x480, 640x480, 640x360, 352x288, 352x240
	Frame Rate	Stream 1: Max. 25FPS @ 2592x1944 Stream 2: Max. 25FPS @ 640x480 Stream 3: Max. 25FPS @ 640x480
	Bit Rate Control	CBR/VBR/VBR+
	Bit Rate	Stream 1: 1,000-8,000kbps Stream 2: 600-2,000kbps Stream 3: 600-2,000kbps
	Day/Night	True D&N with ICR (Auto/Day/Night/Schedule)
	Backlight Compensation	Yes
	Wide Dynamic Range	True WDR
	White Balance	ATW/Manual (Indoor/Fluorescent/Outdoor)
	Gain Control	Auto
	Noise Reduction	3D-DNR (Auto/Manual)
	Region of Interest	Manual (Max. 8 Regions)
	Defog	Yes
	Slow Shutter	Off/X2/X4/X8
	Image Setting	Mirror/Flip
	Image Adjustment	Brightness, Contrast, Colour, Sharpness
	Privacy Masking	Yes (Max. 4 Areas)
Motion Detection	Yes (Max. 4 Areas)	
Tamper Detection	Yes	
Deep Learning Motion Detection	Yes (Human Detection)	
Deep Learning Video Analytics	-	
Transmission Distance	Max. 100m over Ethernet	
Network	Ethernet	RJ45 10M/100M Ethernet x1
	Protocol	IPv4, IPv6, IGMP, ICMP, ARP, TCP, UDP, DHCP, RTP, RTSP, RTCP, DNS, DDNS, NTP, SMTP, FTP, UPnP, HTTP, HTTPS, SSL/TLS
	Interoperability	ONVIF Profile S, HTTP/RTSP API
	ONVIF Channels	Max. 4 Streams
	Streaming Method	Unicast/Multicast
Interface	Max. User Access	x10
	Edge Storage	MicroSD (Snapshot), Local PC (Snapshot/Recording)
	Video Interface	-
	Alarm Interface	Alarm In x1, Alarm Out x1
	Audio Interface	Audio In x1, Audio Out x1
	Audio Compression	G.711u-law (8kHz)
	RS-485	-
	Control Protocol	N/A
	Reset Button	Yes
	Power Supply	PoE/DC12V/AC24V
General	Power Consumption	PoE: Max. 11.6W, DC12V: Max. 10.3W, AC24V: Max. 13.1W
	Power Output	DC12V (Max. 100mA)
	Operating Temperature	-20°C to +50°C
	Operating Humidity	0% to 90%
	Ingress Protection	IP66
	Vandal Resistance	-
	Housing Materials	Aluminum Diecasting
	RAL	CVP9329DEIREL-IP5M-Z: RAL 9010 Pure White CVP9329DEIREL-IP5M-Z-G: RAL 7021 Black Grey
	Dimensions	Ø120mm x (H) 105.5mm
	Net Weight	≈550g
Gross Weight	≈650g	
Certification	Certifications CE/RoHS	

DIMENSIONS

All measurements are in mm.

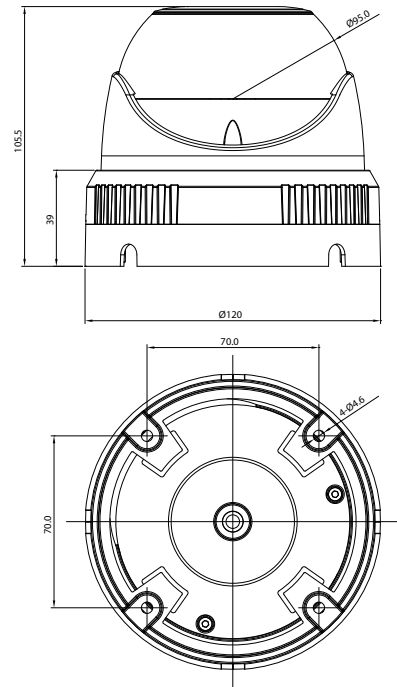

ORDER CODE

- **CVP9329DEIREL-IP5M-Z** Concept Pro 5MP IP Enhanced Low Light Motorised External Eyeball Camera
- **CVP9329DEIREL-IP5M-Z-G** Concept Pro 5MP IP Enhanced Low Light Motorised External Eyeball Camera (Black Grey)

OTHER PRODUCTS IN THE RANGE

- **CVP9329DLIREL-IP8M-Z** Concept Pro 8MP IP Deep Learning Motorised External Eyeball Camera
- **CVP9329DLIREL-IP8M-Z-G** Concept Pro 8MP IP Deep Learning Motorised External Eyeball Camera (Black Grey)

RECOMMENDED ACCESSORIES

- **CP-BASE-1-V2** Concept Pro Small Junction Box
- **CP-BASE-1-V2-G** Concept Pro Small Junction Box - Black Grey
- **CP-WM-1-V2** Concept Pro Small Wall Mount
- **CP-WM-1-V2-G** Concept Pro Small Wall Mount - Black Grey
- **CP-PM-1-V2** Concept Pro Small Pendant Mount
- **CP-PM-1-V2-G** Concept Pro Small Pendant Mount - Black Grey
- **CP-PLM-V2** Concept Pro Pole Mount
- **CP-CM-V2** Concept Pro Corner Mount
- **CAT6-305 305m** CAT6 Cable (Green)
- **VA-SW4/8/16POE-IP** 4/8/16 Channel PoE Switch

COMPATIBLE
WITH



CONCEPT PRO
IP RECORDING
RANGE

CVP9329DEIREL-IP5M-Z CVP9329DEIREL-IP5M-Z-G



Concept Pro 5MP IP Enhanced Low Light
Motorised External Eyeball Camera

ACCESSORIES

DIMENSIONS

CP-BASE-1-V2 CP-BASE-1-V2-G

Concept Pro Small
Junction Box

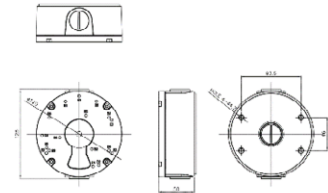

CP-PM-1-V2 CP-PM-1-V2-G

Concept Pro Small
Pendant Mount

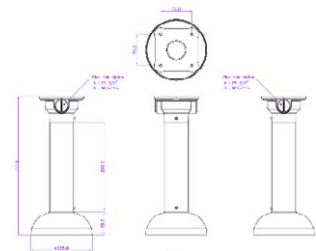

CP-WM-1-V2 CP-WM-1-V2-G

Concept Pro Small
Wall Mount

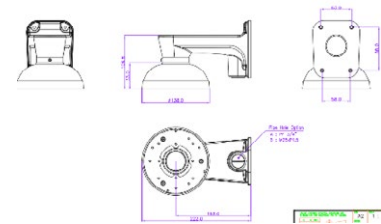
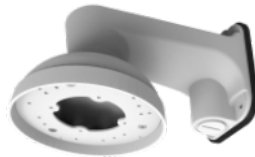

CP-PLM-V2

Concept Pro Pole Mount
(can be combined with
CP-BASE-1-V2)

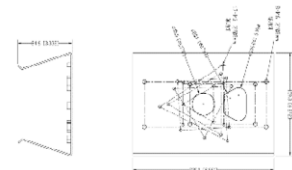

CP-CM-V2

Concept Pro Corner Mount
(can be combined with
CP-BASE-1-V2)

