



# Concept Pro

<b>5MP</b>	<b>2.8mm Fixed Lens</b>	<b>30M IR</b>	<b>4 in 1</b>
------------	-------------------------	---------------	---------------

## CVP9316IREL-AHD5M/2.8 CVP9316IREL-AHD5M-G/2.8

Concept Pro 5MP 4-in-1 Analogue Fixed Lens External Turret Camera

The CVP9316IREL-AHD5M/2.8 model is a 4-in-1 analogue camera that has been designed to deliver the highest image quality for demanding external environments. This weather-resistant external turret features a 2.8mm fixed lens, smart infrared LEDs with 30m illumination range, and provides crisp 5-megapixel video with true wide dynamic range and enhanced low light performance. This camera is also designed for excellent compatibility with the Concept Pro range of hybrid digital video recorders.



### True Wide Dynamic Range

With true wide dynamic range, this camera can capture sharp images throughout the entire field of view, even when there are severe differences between light levels.

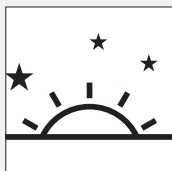

### Enhanced Low Light Performance

This CCTV camera utilises an Enhanced Low Light CMOS sensor with greater light sensitivity, resulting in the camera capturing colour images long after standard CCTV cameras have switched to black and white night mode.

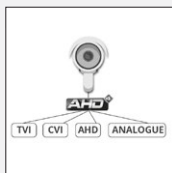

### Four-in-one solution

Don't be tied down to any single analogue platform. With Concept Pro 4-in-1 cameras you have the freedom to install whichever CCTV platform you like, whether you install AHD, TVI, CVI, or traditional analogue systems.

### KEY FEATURES

- ◆ Max. 20FPS @ 5MP
- ◆ 2.8mm Fixed Lens
- ◆ Up to 30m Smart IR Illumination
- ◆ 4-in-1 Operation (AHD/TVI/CVI/CVBS)
- ◆ Enhanced Low Light Performance
- ◆ True Wide Dynamic Range

### OTHER FEATURES

- ◆ DC12V Power Input
- ◆ Up the Coax Coaxitron Support
- ◆ AGC, 3D-DNR, BLC
- ◆ IP66-rated

### ANALOGUE HD TYPICAL CABLE DISTANCE



	5MP	2MP	720P
<b>COAX (RG59)</b>	UP TO 500M	UP TO 500M	UP TO 500M
<b>CAT5e</b>	UP TO 200M	UP TO 305M	UP TO 350M
<b>CAT6</b>	UP TO 200M	UP TO 305M	UP TO 350M

\*Approximate distances calculated using HD MasterBaluns. Actual transmission range will vary depending on type and quality of cable and baluns.



# CVP9316IREL-AHD5M/2.8

# CVP9316IREL-AHD5M-G/2.8

Concept Pro 5MP 4-in-1 Analogue  
Fixed Lens External Turret Camera

# Concept Pro

## SPECIFICATION

Model/Feature	CVP9316IREL-AHD5M/2.8 CVP9316IREL-AHD5M-G/2.8
Image Sensor	1/2.8" Progressive Scan CMOS
Video Output Type	AHD/TVI/CVI/CVBS
Signal System	PAL/NTSC
Min. Illumination	Colour: 0.4 lux (Enhanced Low Light) B&W: 0.04 lux (Enhanced Low Light) 0 lux with IR on
<b>Camera</b>	
Electronic Shutter	Auto
S/N Ratio	≥50dB
IR LEDs	x2
IR Illumination Range	Max. 30m
IR Control	On/Off
Adaptable IR	Auto
Pivot Axis	Pan: 0-349°, Tilt: 0-80°, Rotation: 0-360°
Lens Type	Fixed
Mount Type	Built-in
Focal Length	f=2.8mm
<b>Lens</b>	
Aperture	F2.0
Angle of View	H: 104°, V: 76°, D: 112°
Focus	Fixed
Iris	Fixed
Resolution	5MP (2592x1944), 4MP (2560x1440), 2MP (1920 x 1080), SD (960 x 576)
Frame Rate	AHD/TVI: 12.5/20FPS @ 5MP, 15/25/30FPS @ 4MP, 25/30FPS @ 2MP CVI: 25/30FPS @ 4MP, 25/30FPS @ 2MP CVBS: 25/30FPS @ SD
Day/Night	True Day & Night with ICR (Auto/Colour/B&W/EXT)
Backlight Compensation	BLC/Global
Wide Dynamic Range	True WDR
White Balance	Pro/Gray World
Gain Control	Auto
Noise Reduction	3D-DNR (Auto/Manual)
Motion Detection	-
Defog	-
Image Setting	Mirror
Image Adjustment	Brightness, Sharpness, Contrast, Saturation
Privacy Masking	-
Sens-Up	-
Transmission Distance	Max. 500m (1Vp-p 75Ω)
Video Output	x1 1.0Vp-p 75Ω BNC (AHD/TVI/CVI/CVBS)
<b>Interface</b>	
Audio Interface	-
RS-485	-
Control Protocol	N/A
Up the Coax (Coaxitron) Support	Yes
OSD Buttons	Yes
Power Supply	DC12V±10%
Power Output	-
Power Consumption	Max. 4.8W
Operating Temperature	-30°C to +40°C
Operating Humidity	20-80% RH
<b>General</b>	
Ingress Protection	IP66
Impact Resistance	-
Housing Materials	Aluminum Diecasting
RAL	CVP9316IREL-AHD5M/2.8: RAL 9010 Pure White CVP9316IREL-AHD5M-G/2.8: RAL 7021 Black Grey
Dimension	Ø120 x (H) 94.8mm
Net Weight	≈480g
Gross Weight	≈630g
<b>Certification</b>	
Certifications	CE

## DIMENSIONS

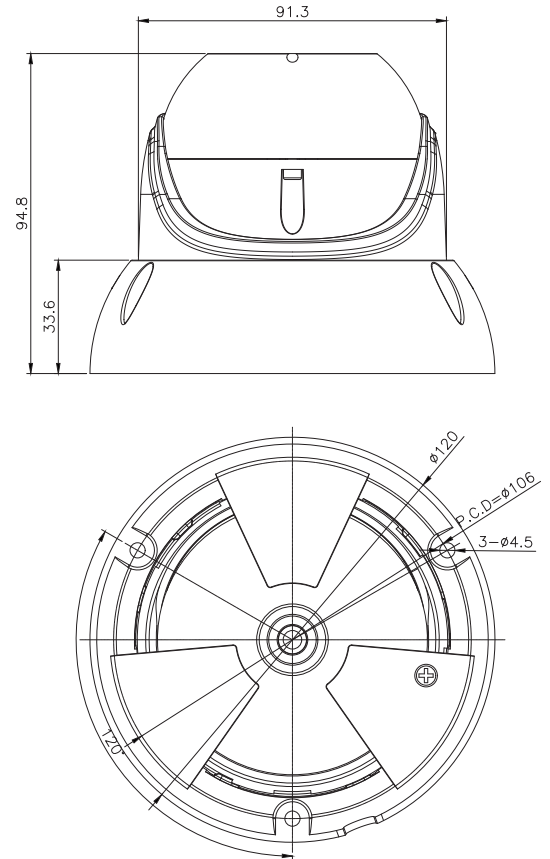

## ORDER CODE

- **CVP9316IREL-AHD5M/2.8** Concept Pro 5MP 4-in-1 Analogue Fixed External Turret Camera
- **CVP9316IREL-AHD5M-G/2.8** Concept Pro 5MP 4-in-1 Analogue Fixed External Turret Camera (Grey)

## OTHER PRODUCTS IN THE RANGE

- **CVP9316IREL-AHD2M/2.8** Concept Pro Lite 2MP 4-in-1 Analogue Fixed External Turret Camera

## RECOMMENDED ACCESSORIES

- CP-BASE-1-V2 Concept Pro Small Junction Box
- CP-WM-1-V2 Concept Pro Small Wall Mount
- CP-PM-1-V2 Concept Pro Small Pendant Mount
- CP-PLM-V2 Concept Pro Pole Mount
- CP-CM-V2 Concept Pro Corner Mount
- RG59K-100 RG59 Coaxial Cable 100m (Black)
- RG59K-500 RG59 Coaxial Cable 500m (Black)

COMPATIBLE  
WITH



CONCEPT PRO  
AHD RECORDING  
RANGE

# CVP9316IREL-AHD5M/2.8 CVP9316IREL-AHD5M-G/2.8

Concept Pro 5MP 4-in-1 Analogue  
Fixed Lens External Turret Camera

# Concept Pro

## ACCESSORIES

## DIMENSIONS

### CP-BASE-1-V2

Concept Pro Small  
Junction Box

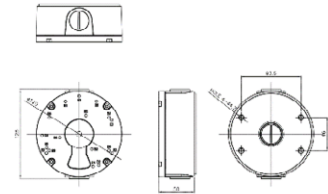

### CP-PM-1-V2

Concept Pro Small  
Pendant Mount

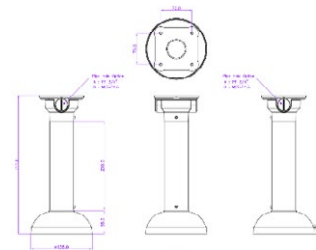

### CP-WM-1-V2

Concept Pro Small  
Wall Mount

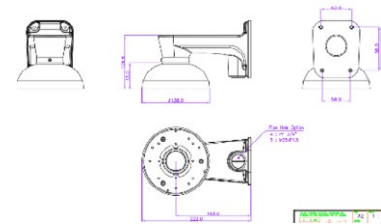
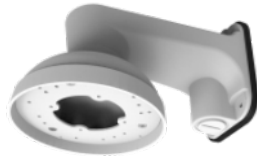

### CP-PLM-V2

Concept Pro Pole Mount  
(can be combined with  
CP-BASE-2-V2)

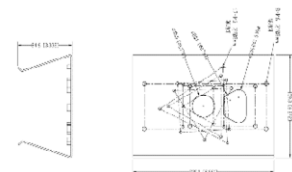

### CP-CM-V2

Concept Pro Corner Mount  
(can be combined with  
CP-BASE-2-V2)

