



Concept Pro

- 5MP**
- 2.8-12mm
Motorised
Lens**
- 80M
IR**
- IP**

AIR8025DEEL-IP5M-Z

Concept Pro 5MP IP Enhanced Low Light Motorised External Large Bullet Camera

The AIR8025DEEL-IP5M-Z model is an IP camera that has been designed to deliver the highest image quality for long-range external environments. This external large bullet features a motorised lens, smart infrared LEDs with 80m illumination range, and provides crisp 5-megapixel video. It comes equipped with alarm and audio functionality as well as a power output for the most advanced installation needs. This camera is also designed for excellent compatibility with the Concept Pro range of network video recorders.



Deep Learning Motion Detection

Reduce false motion detection alarms by up to 95% using new Deep Learning Motion Detection technology. Trained with deep learning algorithms, the camera can recognise and trigger motion detection events only if a person is detected in the specified area. As a result, false alarms from sources such as lights, animals, foliage, weather, and other objects are effectively filtered and reduced.



Intelligent, Efficient Bit Rate Control

Reduce camera streaming bit rates by up to 90% by using Variable Bit Rate (VBR) or VBR+ smart bit rate control settings. These dynamic features maximise overall image quality while minimising camera stream bit rates. This results in lower network bandwidth usage and extended recording storage retention time.

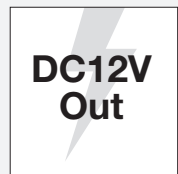

DC12V Power Output

This CCTV camera also provides a DC12V 100mA power output that can be conveniently used to power some auxiliary equipment rather than using a separate power supply adapter.



Number Plate Capture

Configure the camera to operate as a Number Plate Capture camera at up to 30m/70mph with just a few simple configurations.

KEY FEATURES

- ◆ Max. 25FPS @5MP
- ◆ 2.8-12mm Motorised Lens
- ◆ Up to 80m Smart IR Illumination
- ◆ Deep Learning Motion Detection
- ◆ H.265 Video Codec & VBR+ Smart Bit Rate Control
- ◆ Alarm & Audio I/O

OTHER FEATURES

- ◆ PoE/DC12V/AC24V Power Input & DC12V Power Output
- ◆ True WDR, ATW, BLC, Defog, 3D-DNR
- ◆ Manual Regions of Interest
- ◆ ONVIF Profile S Compliant



AIR8025DEEL-IP5M-Z

Concept Pro 5MP IP Enhanced Low Light
Motorised External Large Bullet Camera



SPECIFICATION

Model/Feature	AIR8025DEEL-IP5M-Z	
Video Output Type	IP	
Image Sensor	1/2.8" Progressive Scan CMOS	
Signal System	PAL/NTSC	
Min. Illumination	Enhanced Low Light Performance Colour: 0.003 Lux @ (F1.4, AGC ON) B&W: 0 lux with IR LEDs on	
Camera	Electronic Shutter	Auto/Manual, 1/25 to 1/5,000s
	S/N Ratio	≥48.8dB
	IR LEDs	x8
	IR Illumination Range	Max. 80m
	IR Control	Auto/Off
	Adaptable IR	Auto
	Pan/Tilt/Rotation Range	Pan: 0°-360°, Tilt: 0°-90°, Rotation: 0°-360°
Lens	Lens Type	Motorised
	Mount Type	Built-in
	Focal Length	f=2.8-12mm
	Aperture	F1.4
Angle of View	H: 95.9-29.8°, V: 67.3-22.3°, D: 123.7-36.51°	
Focus	Auto/Manual	
Iris	DC Auto Iris	
Video	Compression	H.265/H.264 with VBR+ Smart Codec Option
	Streaming Capability	Triple Streaming + SVC Stream
	Resolution	2592x1944, 2592x1520, 2304x1296, 2048x1536, 1920x1080, 1280x1024, 1024x768, 1280x720, 704x576, 704x480, 640x480, 640x360, 352x288, 352x240
	Frame Rate	Stream 1: Max. 25FPS @ 2592x1944 Stream 2: Max. 25FPS @ 640x480 Stream 3: Max. 25FPS @ 640x480
	Bit Rate Control	CBR/VBR/VBR+
	Bit Rate	Stream 1: 1,000-8,000kbps Stream 2: 600-2,000kbps Stream 3: 600-2,000kbps
	Day/Night	True D&N with ICR (Auto/Day/Night/Schedule)
	Backlight Compensation	Yes
	Wide Dynamic Range	True WDR
	White Balance	ATW/Manual (Indoor/Fluorescent/Outdoor)
	Gain Control	Auto
	Noise Reduction	3D-DNR (Auto/Manual)
	Region of Interest	Manual (Max. 8 Regions)
	Defog	Yes
	Slow Shutter	Off/X2/X4/X8
	Image Setting	Mirror/Flip
	Image Adjustment	Brightness, Contrast, Colour, Sharpness
Privacy Masking	Yes (Max. 4 Areas)	
Motion Detection	Yes (Max. 4 Areas)	
Tamper Detection	Yes	
Deep Learning Motion Detection	Yes (Human Detection)	
Deep Learning Video Analytics	-	
Transmission Distance	Max. 100m over Ethernet	
Number Plate Capture	Yes (Pending User Configuration), Max. 30m.70MPH	
Network	Ethernet	RJ45 10M/100M Ethernet x1
	Protocol	IPv4, IPv6, IGMP, ARP, TCP, UDP, DHCP, RTP, RTSP, RTCP, DNS, DDNS, NTP, SMTP, FTP, UPnP, HTTP, HTTPS, SSL/TLS
	Interoperability	ONVIF Profile S, HTTP/RTSP API
	ONVIF Channels	Max. 4 Streams
Interface	Streaming Method	Unicast/Multicast
	Max. User Access	x10
	Edge Storage	MicroSD (Snapshot), Local PC (Snapshot/Recording)
	Video Interface	-
	Alarm Interface	Alarm In x1, Alarm Out x1
	Audio Interface	Audio In x1, Audio Out x1
	Audio Compression	G.711u-law (8kHz)
	RS-485	-
	Control Protocol	N/A
	Reset Button	Yes
General	Power Supply	PoE/DC12V/AC24V
	Power Consumption	TBD
	Power Output	DC12V (Max. 100mA)
	Operating Temperature	-20°C to +50°C
	Operating Humidity	0% to 90%
	Ingress Protection	IP66
	Vandal Resistance	-
	Housing Materials	Aluminum Diecasting
	RAL	RAL 7021 Black Grey
	Dimensions	Ø86mm x (L) 270mm without sunshield
Net Weight	≈1,100g	
Gross Weight	≈1,400g	
Certification	Certifications CE	

DIMENSIONS

All measurements are in mm.

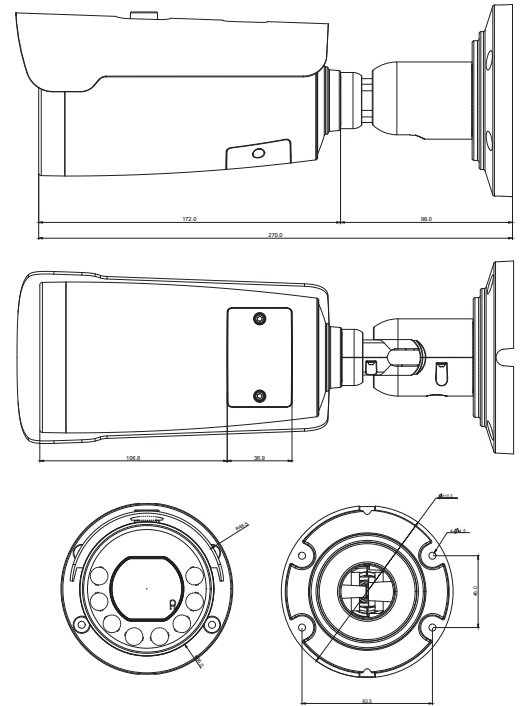

ORDER CODE

- **AIR8025DEEL-IP5M-Z** Concept Pro 5MP IP Enhanced Low Light Motorised External Large Bullet Camera

OTHER PRODUCTS IN THE RANGE

- **AIR8010DEUL-IP2M-Z** Concept Pro 2MP IP 10x Motorised External Large Bullet Camera
- **AIR8025DLEL-IP8M-Z** Concept Pro 8MP IP Deep Learning Motorised External Large Bullet Camera

RECOMMENDED ACCESSORIES

- **CP-BASE-1-V2-G** Concept Pro Small Junction Box - Black Grey
- **CP-WM-1-V2-G** Concept Pro Small Wall Mount - Black Grey
- **CP-PM-1-V2-G** Concept Pro Small Pendant Mount - Black Grey
- **CP-PLM-V2** Concept Pro Pole Mount
- **CP-CM-V2** Concept Pro Corner Mount
- **CAT6-305 305m** CAT6 Cable (Green)
- **VA-SW4/8/16POE-IP** 4/8/16 Channel PoE Switch

COMPATIBLE
WITH



CONCEPT PRO
IP RECORDING
RANGE

AIR8025DEEL-IP5M-Z

Concept Pro 5MP IP Enhanced Low Light Motorised External Large Bullet Camera

ACCESSORIES

DIMENSIONS

CP-BASE-1-V2-G

Concept Pro Small Junction Box

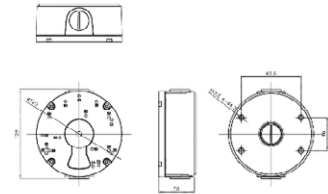

CP-PM-1-V2-G

Concept Pro Small Pendant Mount

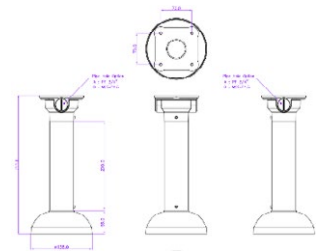
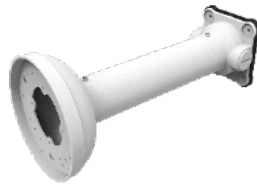

CP-WM-1-V2-G

Concept Pro Small Wall Mount

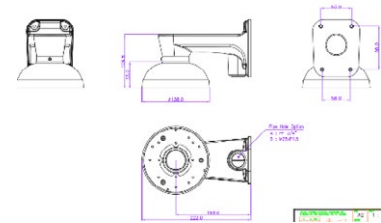
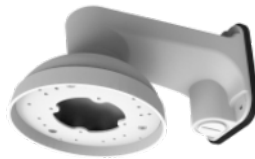

CP-PLM-V2

Concept Pro Pole Mount
(can be combined with CP-BASE-1-V2)

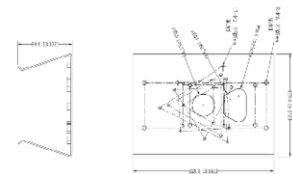

CP-CM-V2

Concept Pro Corner Mount
(can be combined with CP-BASE-1-V2)

