



Concept Pro

2MP	2.8mm Fixed Lens	30M IR	4 in 1
------------	-------------------------	---------------	---------------

CVP9316IREL-AHD2M/2.8

Concept Pro Lite 2MP 4-in-1 Analogue Fixed External Turret Camera

The CVP9316IREL-AHD2M/2.8 model is a 4-in-1 analogue camera that has been designed to deliver the highest image quality for demanding external environments. This weather-resistant external turret features a 2.8mm fixed lens, smart infrared LEDs with 30m illumination range, and provides crisp 2-megapixel video at real-time frame rates with true wide dynamic range and enhanced low light performance. This camera is also designed for excellent compatibility with the Concept Pro range of hybrid digital video recorders.

WDR

True Wide Dynamic Range
With true wide dynamic range, this camera can capture sharp images throughout the entire field of view, even when there are severe differences between light levels.

Enhanced Low Light Performance
This CCTV camera utilises an Enhanced Low Light CMOS sensor with greater light sensitivity, resulting in the camera capturing colour images long after standard CCTV cameras have switched to black and white night mode.

Four-in-one solution
Don't be tied down to any single analogue platform. With Concept Pro 4-in-1 cameras you have the freedom to install whichever CCTV platform you like, whether you install AHD, TVI, CVI, or traditional analogue systems.

KEY FEATURES

- ◆ Max. 25FPS @ 2MP
- ◆ 2.8mm Fixed Lens
- ◆ Up to 30m Smart IR Illumination
- ◆ 4-in-1 Operation (AHD/TVI/CVI/CVBS)
- ◆ Enhanced Low Light Performance
- ◆ True Wide Dynamic Range

OTHER FEATURES

- ◆ DC12V Power Input
- ◆ Up to the Coax Coaxitron Support
- ◆ AGC, Sens-up, AWB, BLC, HLC, Defog
- ◆ IP66-rated

ANALOGUE HD TYPICAL CABLE DISTANCE



	5MP	2MP	720P
COAX (RG59)	UP TO 500M	UP TO 500M	UP TO 500M
CAT5e	UP TO 200M	UP TO 305M	UP TO 350M
CAT6	UP TO 200M	UP TO 305M	UP TO 350M

*Approximate distances calculated using HD MasterBaluns. Actual transmission range will vary depending on type and quality of cable and baluns.

COMPATIBLE WITH



CONCEPT PRO AHD RECORDING RANGE

CVP9316IREL-AHD2M/2.8

Concept Pro Lite 2MP 4-in-1 Analogue
Fixed External Turret Camera

Concept  Pro

SPECIFICATION

Model/Feature	CVP9316IREL-AHD2M/2.8
Image Sensor	1/2.8" Progressive Scan CMOS
Video Output Type	AHD/TVI/CVI/CVBS
Signal System	PAL/NTSC
Min. Illumination	Colour: 0.02 lux (Enhanced Low Light) B&W: 0.002 lux (Enhanced Low Light) 0 lux with IR on
Camera	
Electronic Shutter	Auto/Manual, 1/25-1/25,600s
S/N Ratio	≥50dB
IR LEDs	x2
IR Illumination Range	Max. 30m
IR Control	On/Off
Adaptable IR	Auto
Pivot Axis	Pan: 0-349°, Tilt: 0-80°, Rotation: 0-360°
Lens	
Lens Type	Fixed
Mount Type	Built-in
Focal Length	f=2.8mm
Aperture	F2.0
Angle of View	H: 104°, V: 76°, D: 112°
Focus	Fixed
Iris	Fixed
Video	
Resolution	2MP (1920 x 1080), SD (960 x 576)
Frame Rate	AHD/TVI/CVI: 25/30FPS @ 2MP CVBS: 25/30FPS @ SD
Day/Night	True Day & Night with ICR (Auto/Colour/B&W/EXT)
Backlight Compensation	BLC/HLC
Wide Dynamic Range	True WDR
White Balance	Auto/AutoExt/Preset/Manual
Gain Control	Auto (AGC, 0-20)
Noise Reduction	2D/3D-DNR (High/Middle/Low/Off)
Motion Detection	Yes
Defog	Yes
Image Setting	Freeze, Flip
Image Adjustment	Brightness, Sharpness, Colour Gain, Ace, Gamma
Privacy Masking	Yes
Sens-Up	Yes (x2/x4/x8/x16/x32/Off)
Transmission Distance	Max. 500m (1Vp-p 75Ω)
Video Output	x1 1.0Vp-p 75Ω BNC (AHD/TVI/CVI/CVBS)
Audio Interface	-
Interface	
RS-485	-
Control Protocol	N/A
Up the Coax (Coaxitron) Support	Yes
OSD Buttons	Yes
General	
Power Supply	DC12V±10%
Power Output	-
Power Consumption	Max. 4.8W
Operating Temperature	-30°C to +40°C
Operating Humidity	20-80% RH
Ingress Protection	IP66
Impact Resistance	-
Housing Materials	Aluminum Diecasting
RAL	RAL 9010 Pure White
Dimension	Ø120 x (H) 94.8mm
Net Weight	≈480g
Gross Weight	≈630g
Certification	
Certifications	CE

DIMENSIONS

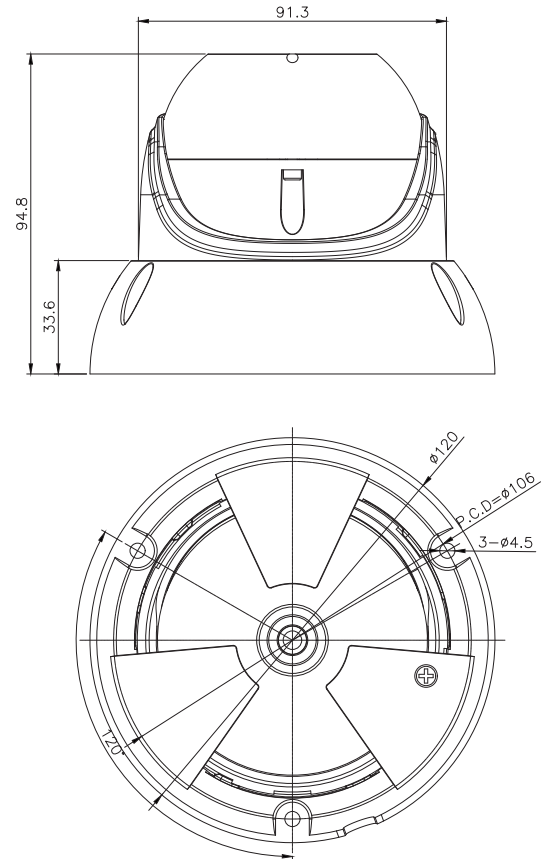

ORDER CODE

- **CVP9316IREL-AHD2M/2.8** Concept Pro Lite 2MP 4-in-1 Analogue Fixed External Turret Camera

OTHER PRODUCTS IN THE RANGE

- **CVP9316IREL-AHD5M/2.8** Concept Pro 5MP 4-in-1 Analogue Fixed External Turret Camera
- **CVP9316IREL-AHD5M-G/2.8** Concept Pro 5MP 4-in-1 Analogue Fixed External Turret Camera (Grey)

RECOMMENDED ACCESSORIES

- CP-BASE-1-V2 Concept Pro Small Junction Box
- CP-WM-1-V2 Concept Pro Small Wall Mount
- CP-PM-1-V2 Concept Pro Small Pendant Mount
- CP-PLM-V2 Concept Pro Pole Mount
- CP-CM-V2 Concept Pro Corner Mount
- RG59K-100 RG59 Coaxial Cable 100m (Black)
- RG59K-500 RG59 Coaxial Cable 500m (Black)

COMPATIBLE
WITH



CONCEPT PRO
AHD RECORDING
RANGE

CVP9316IREL-AHD2M/2.8

Concept Pro Lite 2MP 4-in-1 Analogue
Fixed External Turret Camera

Concept Pro

ACCESSORIES

DIMENSIONS

CP-BASE-1-V2

Concept Pro Small
Junction Box

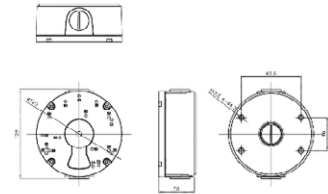

CP-PM-1-V2

Concept Pro Small
Pendant Mount

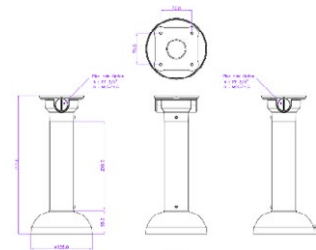
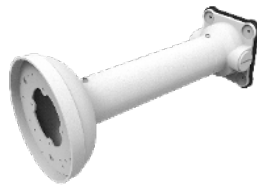

CP-WM-1-V2

Concept Pro Small
Wall Mount

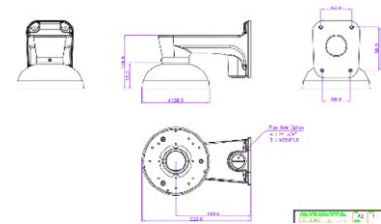
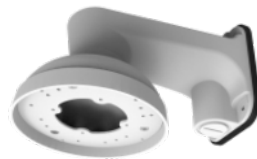

CP-PLM-V2

Concept Pro Pole Mount
(can be combined with
CP-BASE-2-V2)

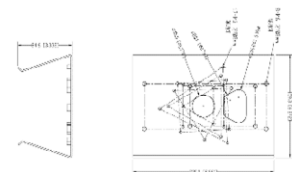

CP-CM-V2

Concept Pro Corner Mount
(can be combined with
CP-BASE-2-V2)

